

The RF Line UHF Linear Power Amplifiers

Designed specifically for the United States digital 3.0 W, mobile radio. The MHW927A/B are capable of wide power range control, operate from a 12.5 V supply and require 1.0 mW of RF input power.

- MHW927A Operates from a 9.5 Volt Bias Supply (V_B)
MHW927B Operates from a 8.0 Volt Bias Supply (V_B)
- Specified 12.5 Volt Characteristics for MHW927A/B:
RF Input Power — 1.0 mW (0 dBm) Max
RF Output Power — 6.0 W
Power Gain — 40 dB Typ
Harmonics — -30 dBc Max @ $2 f_0$
- Linearity (IMD) — -29 dBc Max for 3rd Order; -34 dBc Max for 5th Order
- New Biasing and Control Techniques Providing Dynamic Range and Control Circuit Bandwidth Ideal for USDC
- 50 Ω Input/Output Impedances
- Guaranteed Stability and Ruggedness

MHW927A*
MHW927B

*Motorola Preferred Device

6.0 W
824 to 849 MHz
RF LINEAR
POWER AMPLIFIERS

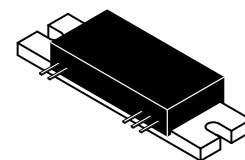

CASE 301AA-01, STYLE 1

MAXIMUM RATINGS (Recommended Values for Safe Operation — Not Guaranteed Performance)

Rating	Symbol	Value	Unit
DC Supply Voltage	V_{S2}, V_{S3}	16.5	Vdc
DC Bias Voltage	V_B	10	Vdc
RF Input Power	P_{in}	3.0	mW
RF Output Power	P_{out}	13	W
Operating Case Temperature Range	T_C	-30 to +100	$^{\circ}C$
Storage Temperature Range	T_{stg}	-30 to +100	$^{\circ}C$

ELECTRICAL CHARACTERISTICS ($V_{S2} = V_{S3} = 12.5$ Vdc; $V_B = 9.5$ Vdc (MHW927A); $V_B = 8.0$ Vdc (MHW927B); $P_{in} \leq 1.0$ mW (MHW927A/B); $T_C = +25^{\circ}C$, 50 ohm system, unless otherwise noted)

Characteristic	Symbol	Min	Typ	Max	Unit
Frequency Range	BW	824	—	849	MHz
Input Power ($P_{out} = 6.0$ W) (1)	P_{in}	—	—	1.0	mW
Efficiency ($P_{out} = 6.0$ W) (1)	η_1	28	30	—	%
Efficiency, Two Tone (P_{out} (Avg.) = 6.0 W; f_1 & f_2 10 kHz apart) (1)	η_2	28	30	—	%
Input VSWR ($P_{out} = 6.0$ W) (1)	VSWR _{in}	—	—	2.5:1	—
Harmonics ($P_{out} = 6.0$ W) (1)					
	$2 f_0$	—	—	-30	dBc
	$3 f_0$	—	—	-45	dBc
Noise Power (In 30 kHz Bandwidth, 45 MHz Above f_0 ; $T_C = +25^{\circ}C$ to $T_C = +100^{\circ}C$; $P_{out} = 6.0$ W) (1)	—	—	—	-82	dBm
Linearity (P_{out} (Avg.) = 6.0 W; f_1 & f_2 are 10 kHz apart) (1)					
	3rd Order IMD	—	-31	-29	dBc
	5th Order IMD	—	-36	-34	dBc
Load Mismatch Stress ($V_{S2} = V_{S3} = 16$ Vdc; $P_{out} = 12.5$ W; Pulsed at 50% Duty Cycle; Load VSWR = 20:1, All Phase Angles At Frequency of Test) (1)	ψ	No Degradation In Output Power Between Before and After Test			
Stability ($V_{S2} = V_{S3} = 10$ to 16 Vdc; $P_{out} = 0.012$ to 12 W; Load VSWR = 4:1, All Phase Angles At Frequency of Test) (1)	—	All Spurious Outputs More Than 70 dB Below Desired Signal			

NOTE:

1. Adjust P_{in} for Specified P_{out} .

Preferred devices are Motorola recommended choices for future use and best overall value.

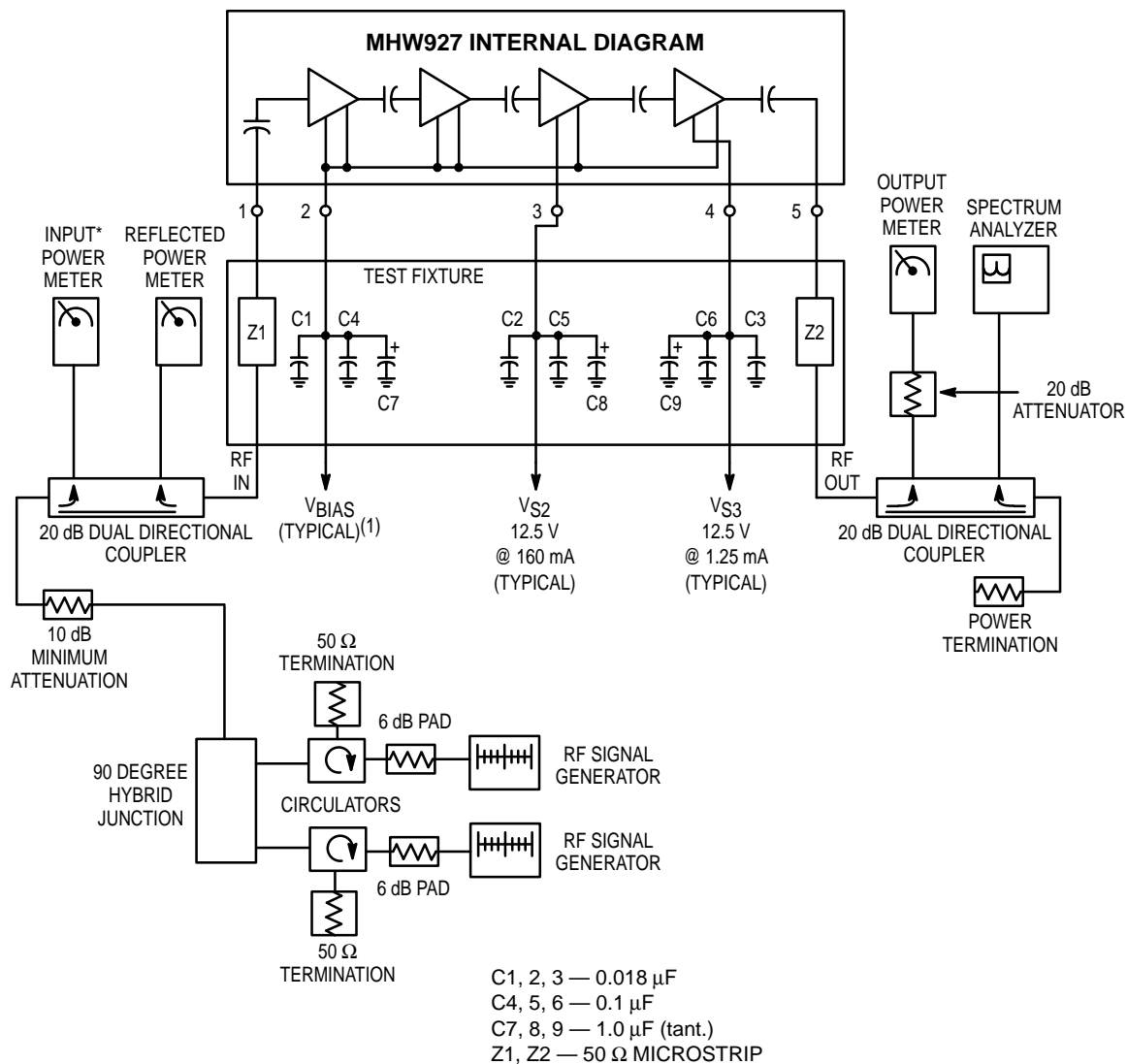

(1) $V_{BIAS} = 9.5 \text{ V @ } 140 \text{ mA}$ (MHW927A) or $8.0 \text{ V @ } 140 \text{ mA}$ (MHW927B)

*Module input power is forward power as sampled by the directional coupler and read on the input power meter.

Figure 1. MHW927A/B Test Circuit Diagram

TYPICAL CHARACTERISTICS

(MHW927A)

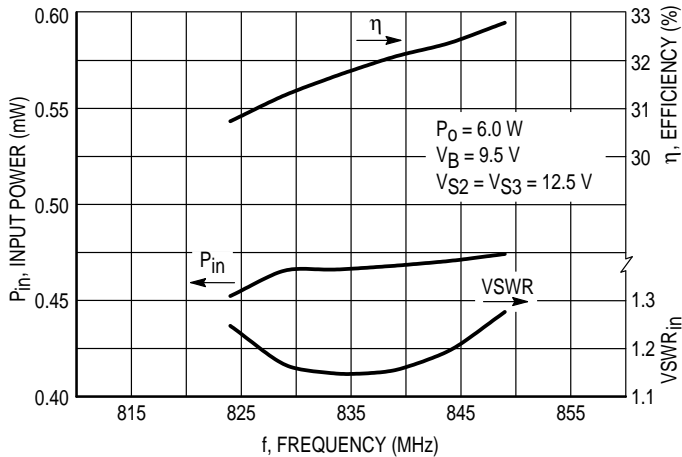

Figure 2. Input Power, Efficiency and VSWR versus Frequency

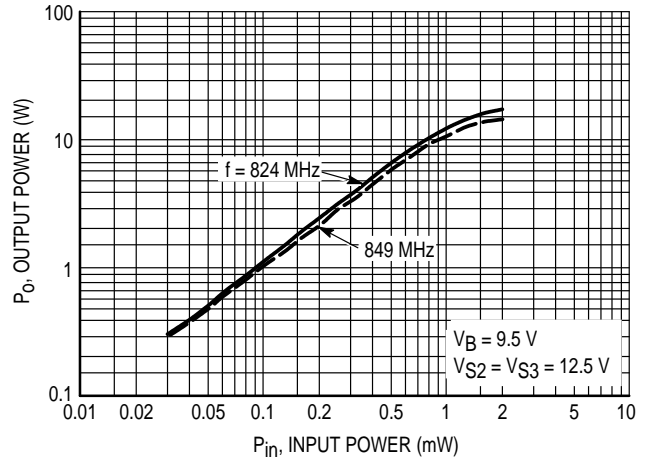

Figure 3. Output Power versus Input Power

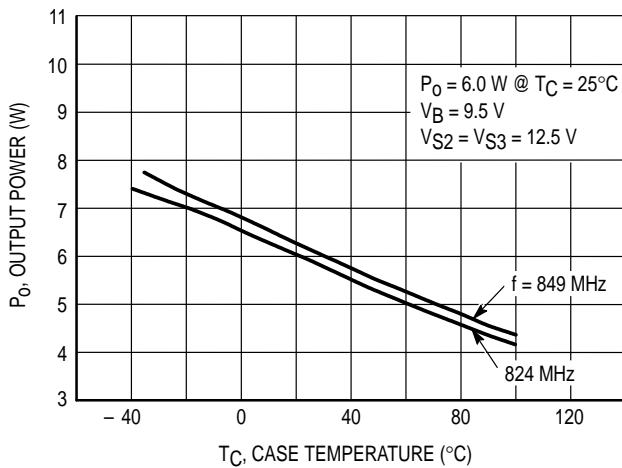

Figure 4. Output Power versus Case Temperature

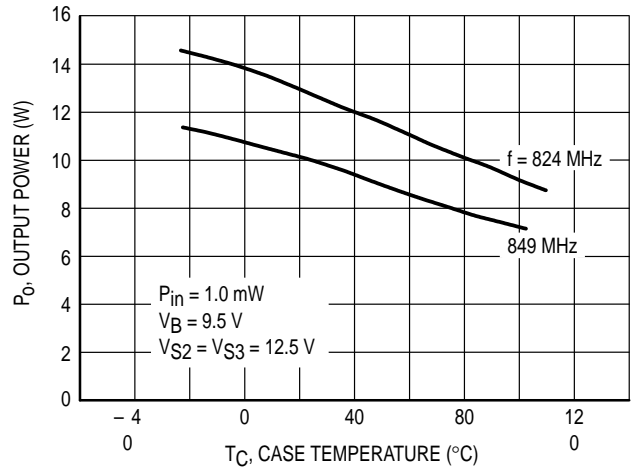

Figure 5. Output Power versus Case Temperature at Maximum Input Power

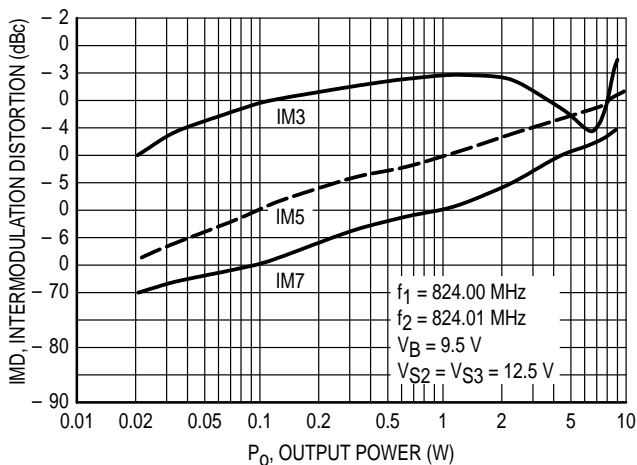

Figure 6. Intermodulation versus Output Power

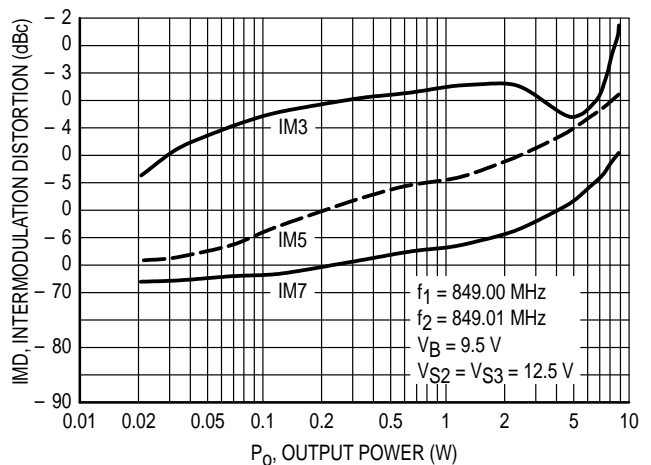

Figure 7. Intermodulation versus Output Power

TYPICAL CHARACTERISTICS

(MHW927B)

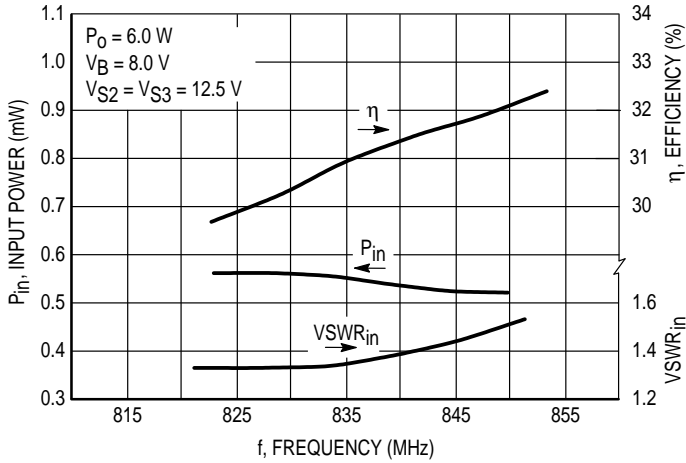

Figure 8. Input Power, Efficiency and VSWR versus Frequency

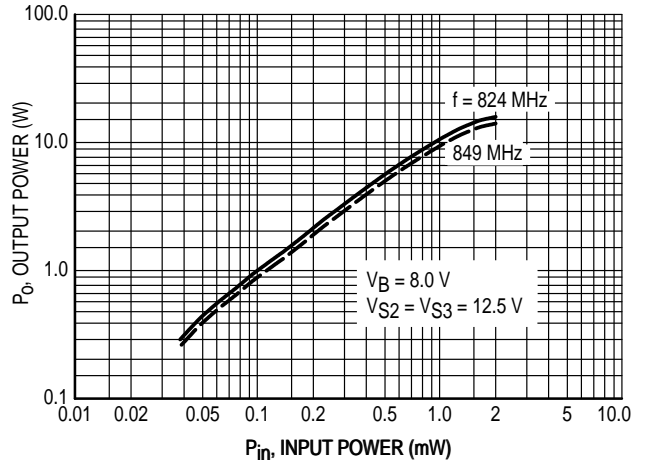

Figure 9. Output Power versus Input Power

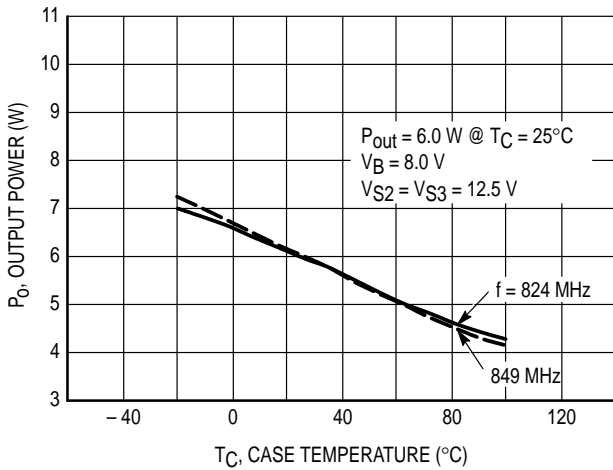

Figure 10. Output Power versus Case Temperature

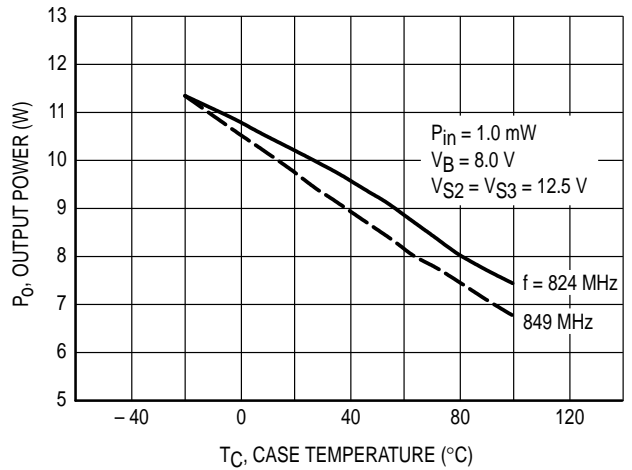

Figure 11. Output Power versus Case Temperature at Maximum Input Power

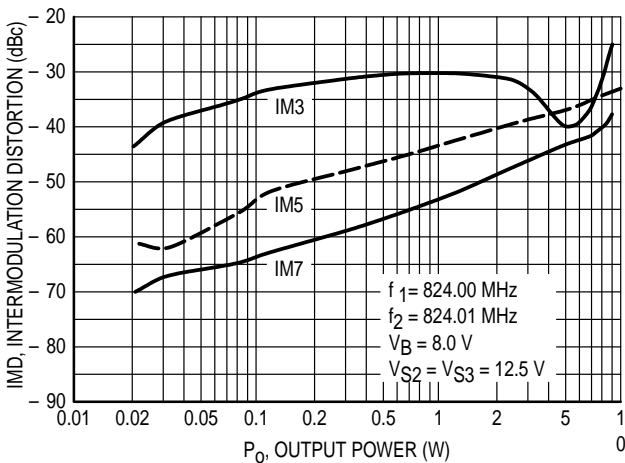

Figure 12. Intermodulation versus Output Power

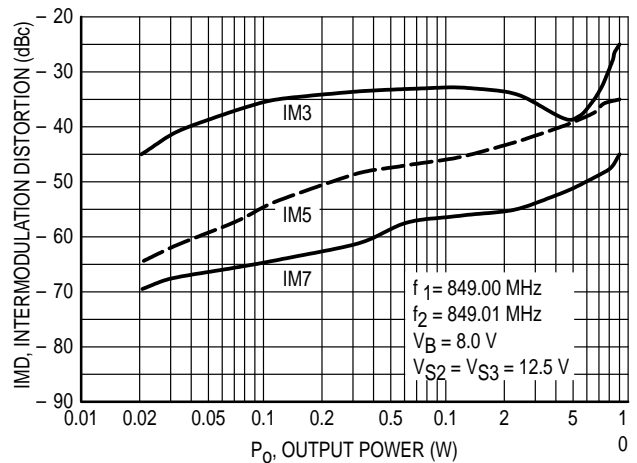
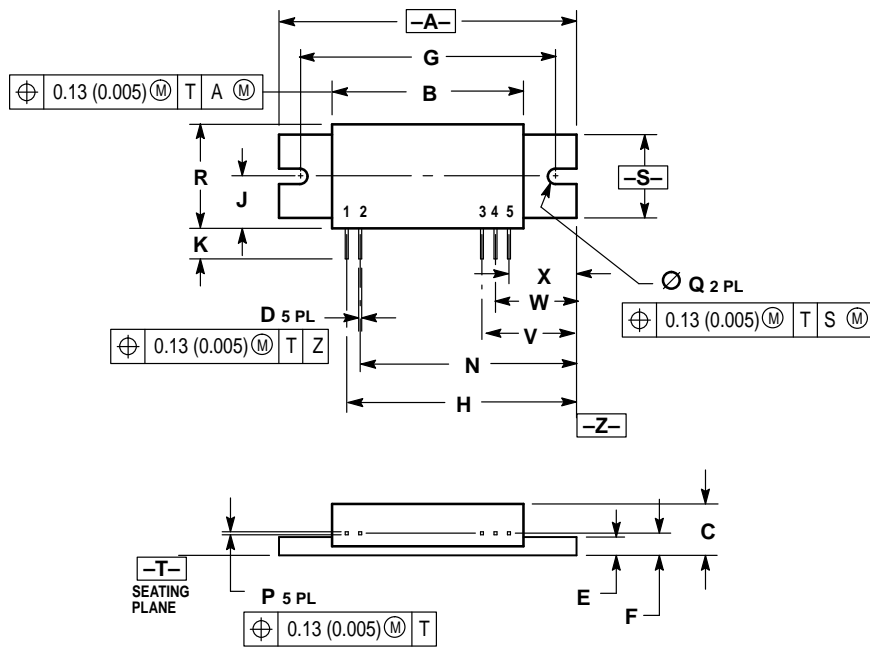

Figure 13. Intermodulation versus Output Power

PACKAGE DIMENSIONS



- NOTES:
 1. DIMENSIONING AND TOLERANCING PER ANSI Y14.5M, 1982.
 2. CONTROLLING DIMENSION: INCH.
 3. DIMENSION F TO CENTER OF LEADS.

DIM	INCHES		MILLIMETERS	
	MIN	MAX	MIN	MAX
A	2.190	2.210	55.63	56.13
B	1.395	1.415	35.44	35.94
C	0.355	0.380	9.02	9.65
D	0.018	0.022	0.46	0.55
E	0.120	0.135	3.05	3.42
F	0.164 BSC		4.16 BSC	
G	1.900 BSC		48.26 BSC	
H	1.700 BSC		43.18 BSC	
J	0.345	0.385	8.77	9.77
K	0.225	—	5.72	—
N	1.600 BSC		40.64 BSC	
P	0.008	0.012	0.21	0.30
Q	0.150	0.160	3.81	4.06
R	0.690	0.770	17.53	19.55
S	0.595	0.615	15.12	15.62
V	0.700 BSC		17.78 BSC	
W	0.600 BSC		15.24 BSC	
X	0.500 BSC		12.70 BSC	

- STYLE 1:
 PIN 1. RF INPUT
 2. V_{BIAS} (8.0 V)
 3. V_{CC2} (12.5 V)
 4. V_{CC3} (12.5 V)
 5. RF OUTPUT

CASE 301AA-01
 ISSUE O

Motorola reserves the right to make changes without further notice to any products herein. Motorola makes no warranty, representation or guarantee regarding the suitability of its products for any particular purpose, nor does Motorola assume any liability arising out of the application or use of any product or circuit, and specifically disclaims any and all liability, including without limitation consequential or incidental damages. "Typical" parameters can and do vary in different applications. All operating parameters, including "Typicals" must be validated for each customer application by customer's technical experts. Motorola does not convey any license under its patent rights nor the rights of others. Motorola products are not designed, intended, or authorized for use as components in systems intended for surgical implant into the body, or other applications intended to support or sustain life, or for any other application in which the failure of the Motorola product could create a situation where personal injury or death may occur. Should Buyer purchase or use Motorola products for any such unintended or unauthorized application, Buyer shall indemnify and hold Motorola and its officers, employees, subsidiaries, affiliates, and distributors harmless against all claims, costs, damages, and expenses, and reasonable attorney fees arising out of, directly or indirectly, any claim of personal injury or death associated with such unintended or unauthorized use, even if such claim alleges that Motorola was negligent regarding the design or manufacture of the part. Motorola and  are registered trademarks of Motorola, Inc. Motorola, Inc. is an Equal Opportunity/Affirmative Action Employer.

Literature Distribution Centers:

USA: Motorola Literature Distribution; P.O. Box 20912; Phoenix, Arizona 85036.

EUROPE: Motorola Ltd.; European Literature Centre; 88 Tanners Drive, Blakelands, Milton Keynes, MK14 5BP, England.

JAPAN: Nippon Motorola Ltd.; 4-32-1, Nishi-Gotanda, Shinagawa-ku, Tokyo 141, Japan.

ASIA PACIFIC: Motorola Semiconductors H.K. Ltd.; Silicon Harbour Center, No. 2 Dai King Street, Tai Po Industrial Estate, Tai Po, N.T., Hong Kong.



MHW927A/D

